

PRODUCT BROCHURE

S201 & S203 Dust Monitors

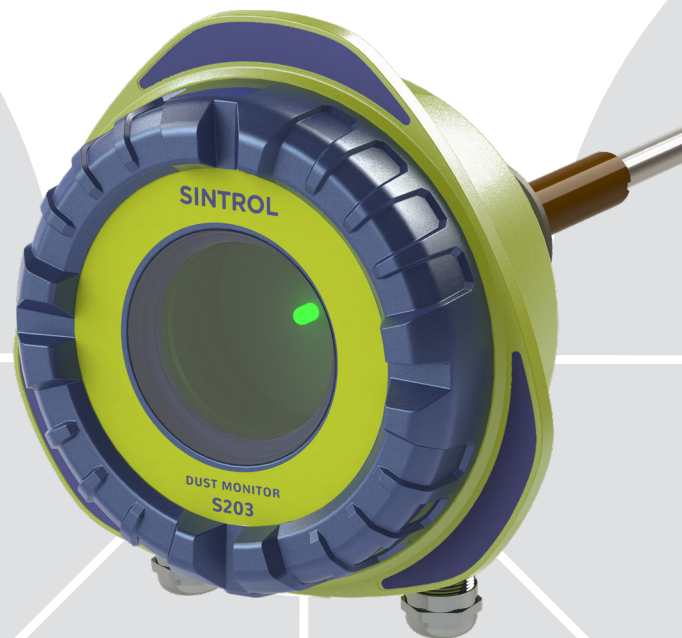

S201 Dust Guard
S203 Trend Monitor
Network and Data Logging

SINTROL
Measuring Matters

S201 DustGuard | S203 Trend Monitor

- Good value for money
- Easy start-up and commissioning
- Rugged design for harsh industrial conditions
- Proven technology
- Accurate dust measurement
- Extremely wide measurement range
- Ex model is suitable for Zone 20, 21 or 22 inside the duct and Zone 21 or 22 outside the duct

The S200 Series

The S200 series comes with a wide range of different probes and process connection options. The new mechanical solutions reflect our field of experience over the last twenty years. Sintrol has engineered and developed the instrument to fit individual processes and demands based on customer needs.

Common Filtration Control

- Straightforward filter leak detection on an ALERT and ALARM signal base.
- Filter performance monitoring and optimization on the mA output signal of S203.
- Minimize product loss by finding even the smallest leakages.
- Identify broken solenoid valves.
- Monitor pulse efficiency and reduce pulse rates.
- Reduce consumption of compressed air.
- Enable preventive maintenance.
- Proactively reduce emergency downtime.

Proven Technology since 1993

Sintrol has become a globally recognized dust monitoring supplier with over 20 000 installations in more than 50 countries. The measuring principle has evolved into a proven standard for dust monitoring needs. Extensive tests have been carried out in Finland and Germany. The results showed excellent linearity over various dust types.

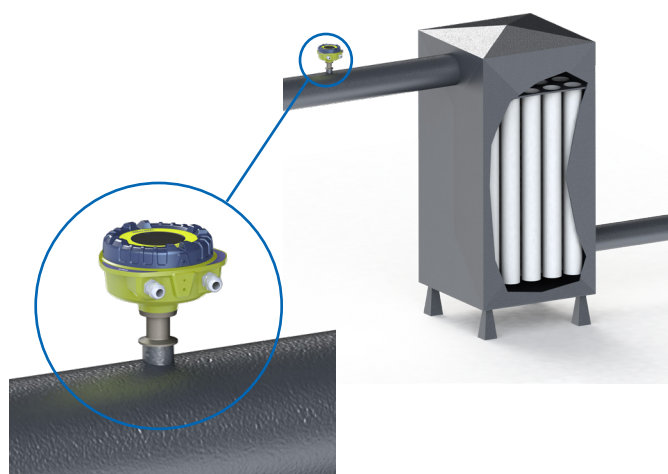

Features

X = Standard	S201	S203	S201 Ex	S203 Ex
Rugged IP66 rated Aluminum pressure cast enclosure	X	X	X	X
Quick clamp process connection for easy installation	X	X	X	X
Green, yellow and red LED for status indication	X	X	X	X
Auto Setup function for efficient commissioning	X	X	X	X
Two dry contact relays to indicate dust alert and dust alarm	X	X	X	X
24 V DC and 100 to 240 V AC power supply	X	X	X	X
USB interface for convenient connection during commissioning	X	X	X	X
DustTool PC-software for parametrization and setup	X	X	X	X
Normalized during production to ensure identical instruments and quality	X	X	X	X
RS485 to communicate with Modbus RTU to your control system or with Sintrol protocol to your PC and DustTool	X	X	X	X
Isolated and active mA-output, to indicate the status ≥ 21 mA or ≤ 3.6 mA is used		X		X
Suitable for the usage in Zone 20, 21 or 22 inside the duct and Zone 21 or 22 outside the duct			X	X

Inductive Electrification Technology

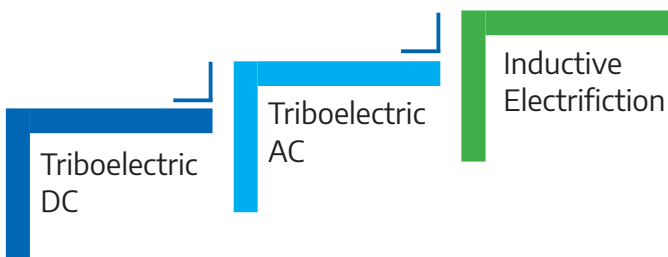

The measurement of Sintrol dust monitors is based on particles interacting with an isolated probe mounted into a duct or stack. When moving particles pass nearby or hit the probe, a signal is induced. This signal is then processed through a series of Sintrol's advanced algorithms to filter out the noise and provides the most accurate dust measurement.

Classic triboelectric technology is based on the DC signal, which is caused by particles making contact with the sensor to transfer charges. Inductive Electrification Technology is based on the Triboelectric AC signal. It is more sensitive and minimizes the influence of sensor contamination, temperature drift and velocity changes. By using Inductive Electrification Technology, it is likely to reach a detection limit as low as 0.01 mg/m³ can be achieved.

DustTool Parametrization Software

The S200 series monitors can be managed and parametrized with the DustTool PC Software. This offers a convenient platform to view the measurement results, to initiate the Auto Setup and adjust the parameters of the monitor. Just connect a USB cable directly to a USB connector. DustTool will automatically detect the interface being used and connect to the device.

IECEX/ATEX Zone approvals

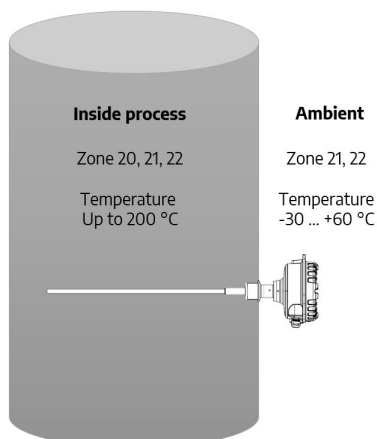

Sintrol's Unique Auto Setup Function

The Auto Setup function is a unique Sintrol Dust Monitor feature which allows for a simple, user friendly setup. During the auto setup procedure, which is done in normal process conditions, the dust monitor will automatically adapt to process conditions and set the measuring range and alarms accordingly. At normal conditions the instrument will show green light and the mA output is set to 5% of range.

In case the measuring point is before the filtration system, the Auto Setup baseline could be several g/m³ and after the filtration system the Auto Setup baseline could be only a few mg/m³. In both cases, no manual range setup is required.

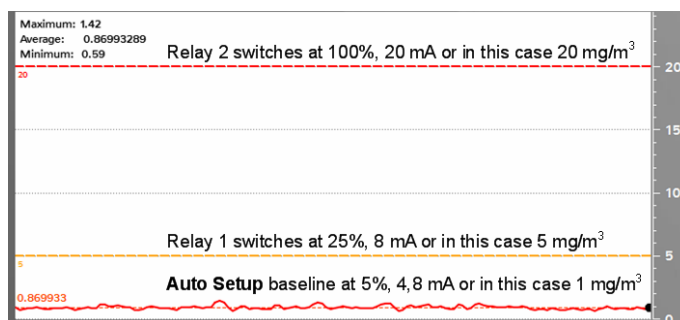

Test Results

Multiple tests show excellent linearity over various dust types. The graph below illustrates the mA output on standard test dust ISO 12103 medium (Arizona Road Dust).

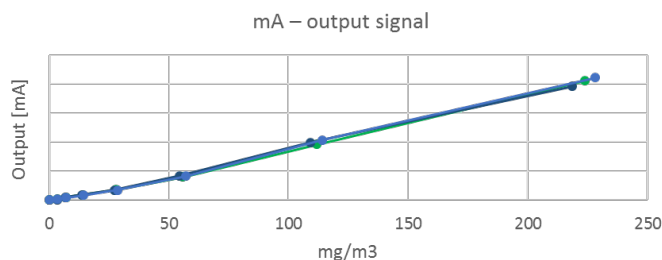

Temperature tests showed close to no impact over the whole temperature range.

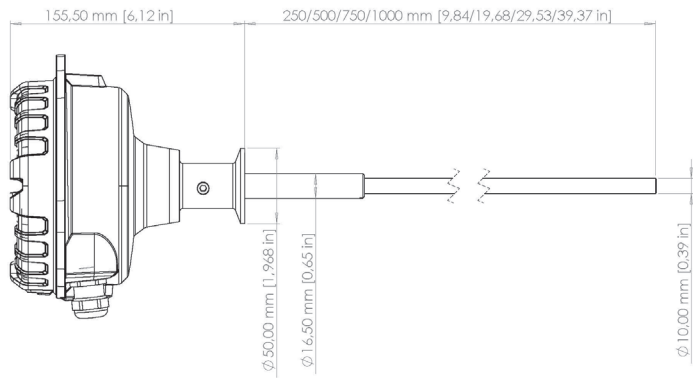
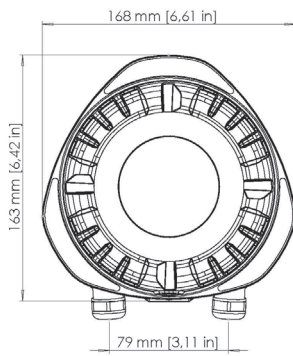

Product Name	S201 PC901013 S201 Ex PC901014 S203 PC901012 S203 Ex PC901024
Measurement objects	Total Suspended Particles (TSP)
Measurement range	Detection Limit 0.01 mg/m ³ Maximum Range up to several g/m ³ , depending on conditions
Measurement principle	Inductive Electrification
Protection code	IP66
Power supply requirements	24 V DC $\pm 10\%$ 100 ... 240 V AC $\pm 10\%$, 50 / 60 Hz
Power consumption	Up to 10 W DC / AC
Output signals	2 \times Independent SPDT dry contact relays, max. 30 V DC / 5 A or 240 V AC / 5 A, $\cos \phi = 1$ Isolated active 4 ... 20 mA output loop*, max. loop resistance 250 Ω
Communication interface	Serial communication RS-485 USB
Communication protocol	Modbus RTU (RS-485) Sintrol network (USB, RF and RS-485)
Process connection	1 1/2" tri-clamp
Cable gland / conduit fitting	PG11
Ambient Conditions	
Temperature	-40 ... 60 °C (-40 ... 140 °F) / -30 ... 60 °C for Ex models
Humidity	Max. 95 % relative humidity (non-condensing)
Materials and Weight	
Enclosure / casing	Aluminum
Weight	1.5 kg (3.3 lbs)
Process conditions	
Temperature	Max. 300 °C (572 °F), optionally up to 700 °C (1292 °F) Max. 250 °C (482 °F) with Teflon-coated probe Max 200 °C for Ex models
Pressure	Max. 600 kPa (87.02 psi) in temperatures up to 300 °C (572 °F) Max. 300 kPa (43.51 psi) in temperatures from 300 °C (572 °F) to 700 °C (1292 °F) when high-temperature process connection is used
Hazardous location approvals Applicable to Ex models	IEC/ATEX: $\text{Ex II 2 D Ex ia tb IIIC T85}^\circ\text{C} \dots 201^\circ\text{C Db Ta} = -30^\circ\text{C to } +60^\circ\text{C}$ US: Zone 20 A Ex ia ta IIIC T85°C...T201°C Da CAN: Ex ia ta IIIC T85°C...T201°C Da US/CAN: CL II, DV 1, GP E, F, G. IS Probe Ta= -30°C to +60°C

SINTROL GROUP OFFICES

*Only available in model S203/S203 Ex

FINLAND
WORLD-
WIDE

Helsinki
Tel. +358 9 561 7360
info@sintrol.com
www.sintrol.fi
www.sintrol.com

INDIA
Representative
Office

New Delhi
Tel. +91 98 1167 6061
india@sintrol.com

CHINA
Representative
Office

Beijing
Tel. +86 10 8788 8681
china@sintrol.com
cn.sintrol.com

JAPAN
Representative
Office

Tokyo
Tel. +81 90 8585 1301
japan@sintrol.com



CERTIFIED BY
Inspector
ISO 9001